

Rasor® Elettromeccanica S.r.l. was established in Milan in 1946 by the two promoting partners Spinelli and Ciminaghi. For more than sixty years it has been producing automatic cutting systems, cutting units for textile applications and electric and pneumatic cutters.



Initially considered as a point of reference for cutting systems in the textile applications, the Rasor® products are nowadays widely used in other fields: chemical, automotive, nautical and sport sectors and in furniture manufacturing.

Rasor® can rely on the professional continuity of three generations, thanks to the precious support of the promoting partner, to his passion, dedication and great experience of seventy years.

The main characteristic of Rasor® is that each working phase, starting from the manufacturing of the product up to its packing and delivery is carried out in Rasor® premises by qualified operators who have professionally grown up following the spirit of the company and of its founders. This ensures the high quality which Rasor® has always considered as essential since the beginning of its activity.

Following the innovative spirit mentioned above, our company is constantly focused on the improvement of the product quality, on the study and development of new materials and technologies.

ACKNOWLEDGMENT

Dear Customer,

thank you for choosing a Rasor® Elettromeccanica S.r.l. product.

Rasor® has been a reference point in the field of cutting systems in the textile, clothing, furniture, tailoring, sport, chemical, automotive, nautical and insulating material sectors for years. Its production has been always synonymous with reliability attested by many of satisfied customers.

Rasor® quality system supervises all the company activities in order to provide the Customer with a service that meets its needs and expectations in terms of product quality, delivery reliability and stock of finished products.

All the parts of the devices have been planned and produced to guarantee an optimum performance. In order to keep the high quality level and the long reliability of the Rasor® products, it is recommended to use only original spare parts and to contact the head office for any maintenance work.

1. GENERAL SAFETY RULES



This manual is an integral part of bench cutter SW12 and must be carefully read before using it since it gives important indications with regards to its safe installation, use and maintenance. Keep it with care.



Before using bench cutter SW12, read carefully the following general safety rules.

- **PACKAGING.**
After taking off the packaging make sure that the bench cutter is intact. In case of doubt do not use it and contact an authorized service centre. Do not leave pieces of packaging (plastic bags, foam polystyrene, boxes, etc.) within the reach of children or disabled persons since they are potential sources of danger.
- **AVOID DANGEROUS ENVIRONMENTS.**
Prevent the bench cutter SW12 components from coming in contact with damp or wet surfaces.
- **KEEP CHILDREN AWAY.**
Unauthorized persons, in particular children, must be kept away from the working area.
- **FEED CABLE.**
Prevent the feed cable from coming in contact with hot objects, pointed surfaces or sharp edges. Never pull the feed cable of the machine. It must never be replaced by the user. If necessary contact professionally qualified staff.
- **KEEP THE WORKING AREA ALWAYS IN ORDER.**
The workplace must always be kept in order and well lightened; liquids or oil traces must not be present.
- **ALWAYS USE BENCH CUTTERS SW12 PROPERLY.**
Use the bench cutters only to carry out the works they have been designed for; do not use them improperly.
- **OBSERVE THE USE OF THE TOOLS.**
Do not cut excessively thick materials and always check blade conditions.
- **AVOID ACCIDENTAL STARTINGS.**
Before connecting bench cutter SW12, make sure that everything is installed properly.
- **CLOTHING.**
Do not use large clothes or accessories that might get stuck in the moving parts.
- **GOGGLES AND PROTECTIVE METAL MESH GLOVES.**
Always use goggles, protective metal mesh gloves approved by Rasor® during use and maintenance operations (according to UNI EN 388:2004 standard).
- **SPARE PARTS.**
During maintenance and replacement operations use only original spare parts. Blade maintenance must be only performed by Rasor® technicians.
- **INSTALLATION.**
Any installation that is not in conformity with these specifications could jeopardize your safety and cancels the warranty.

Informative letter

The installer and the maintenance man must know the content of this manual. Although the main features of the machine described in this manual are not subject to change, **Rasor® Elettromeccanica S.r.l.** reserves the right to modify the components, details and accessories it deems necessary to improve the machine or to meet manufacturing or commercial requirements at any time and without being obliged to update this manual immediately.



WARNING



ALL RIGHTS ARE RESERVED ACCORDING TO THE INTERNATIONAL COPYRIGHT CONVENTIONS,

The reproduction of any part of this manual, in any form, is forbidden without the prior written authorization of Rasor® Elettromeccanica S.r.l.

The content of this guide can be modified without prior notice. Great care has been taken in collecting and checking the documentation contained in this manual to make it as complete and comprehensible as possible.

Nothing contained in this manual can be considered as a warranty, either expressed or implied - including, not in a restrictive way, the suitability warranty for any special purpose. Nothing contained in this manual can be interpreted as a modification or confirmation of the terms of any purchase contract.

Rasor® Elettromeccanica S.r.l. machines have not been conceived to work in areas at risk of explosions and at high risk of fire and they cannot cut wet or damp materials. Moreover, they cannot work in case of rain.

In case of damage or malfunction, table cutter SW12 must not be used until the Customer Care Technical Service has repaired them.

Customer Care Technical Service



For any information, please contact
RASOR® ELETTROMECCANICA S.r.l.
Via V. Caldesi, 6; 20161, MILANO (MI) - ITALY
Tel: +39.02.66221231; Fax: +39.02.66221293
e-mail: info@rasor-cutters.com
web: www.rasor-cutters.com

WARNING



The original configuration of the table cutter must not be changed at all. On receiving the machine make sure the supply corresponds to what has been ordered. In case of non-compliance immediately inform Rasor®. Also make sure the scissors have not been damaged during transport.



2. TRANSPORT AND PACKAGING

The bench cutter is delivered in a cardboard box, inside which there are various options. The code of the ordered product and its serial number are indicated outside the package (see picture 1). The following accessories are contained in a bag inside the package:

- 1) Polygonal blade;
- 2) Butterfly wrench for blade nut disassembly.
- 3) Shuko cable without plug;
- 4) Fuse;
- 5) Drift for blade disassembly.

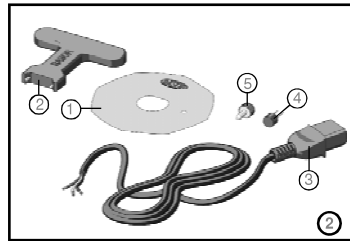
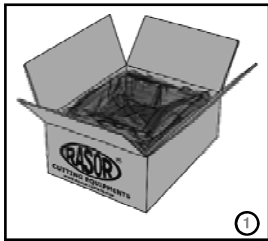

3. PLATE DATA

The manufacturer's identification and CE STANDARD 2006/42/CE conformity plate (see picture below) is located on the front part of the bench cutter. The plate must not be removed at all, even if the machine is resold. Always refer to the serial number (written on the plate itself) when contacting the manufacturer. Several safety warnings are printed on a card which is applied to the cutter feeding cable; such warnings must be strictly followed by everyone dealing with the machine. The company is not to be held responsible for damage to property or accidents to people which might occur if the above-mentioned warnings are not observed. In such a case, the operator is the only person responsible.

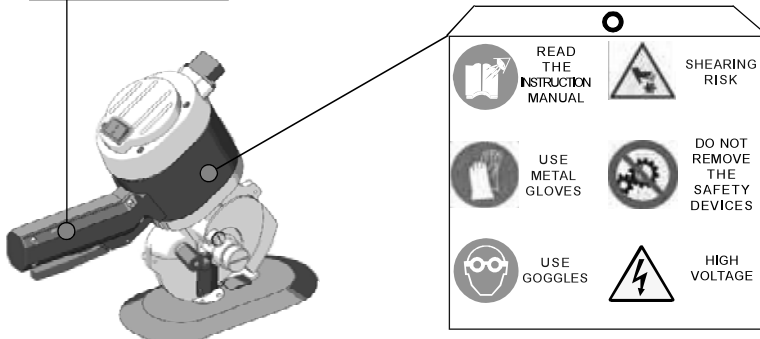

4. PRODUCT DESCRIPTION

The fixtures described in this manual is a bench cutter model SW12 which is used in order to cut strong fabrics. By cutting with the blade and the counterblade always in contact and thanks to the steel upper quality of the blade supplied, SW12 cutter guarantees the clear separation without fraying of the two borders of the cut material. The fixture is extremely versatile, light and precise in the cutting operation. Thanks to the use of a sliding bearing base and an effective cutting system with a polygonal blade, it is possible to use the bench cutter to cut profiles not only in the textile and tannage sector, but also in several industrial sectors such as to cut polymers, thermoacoustic insulators, padding, neoprene, filters, synthetic fabrics and similar fabrics, moquette and internal parts of cars and ships, glass and carbon fibres.

The blade diameter (120mm) and the motor power (180 Watt) gives to this bench cutter remarkable cutting capacity in terms of thickness (up to 5 cm). The wide sliding bearing base allows the operator to slide the cutter on the table without efforts. A sharpener assembled on the cutter heads allows whetting the blade at any moment without disassembling it. After carrying out this operation, it is possible to start cutting again. A high power motor, perfectly balanced, with a high number of revolutions and totally free of maintenance, reduces the vibrations to the minimum, thus making the bench cutter complies with Legislative Decree No. 187 dated 19/8/2005, which adopts European Directive No. 2002/44/CE concerning the risks deriving from mechanical vibrations. The mechanical parts are made of high resistance steel and bronze and require lubrication after several working hours.

Device components			
1	Switch provided with light	9	Polygonal blade
2	Motor cover	10	Plate blocking the threads
3	Connector socket	11	Greaser
4	Motor frame	12	Fixed back protection
5	Sharpener push button	13	Safety catch to enable the starting lever
6	Motor support	14	Control lever
7	Movable front protection	15	Handle
8	Roller platform covered with Teflon®	16	Complementary foot
		17	Counterblade

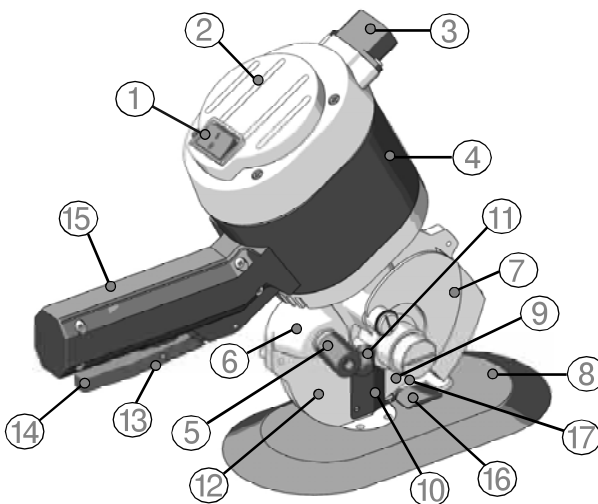

5. TECHNICAL FEATURES

Bench cutter SW12 features	
Blade diameter	120 mm with hard metal counter blade
Blade speed	850 giri/min
Cutting working depth	about 50 mm
Motor power	Monophase 220 V - 180 W
Max. Absorption	2 A
Weight (with feeding cable)	3,400 Kg
Weight with package	4,500 Kg
Electric cable lenght	1,5 mt
Minimum luminosity for working operations	LUX 200
Vibrations at the start up	< 2,5 m/s ²
Temperature	0 ~ 55°C
Humidity	10 ~ 95% without condensate

Features of the available blades	
12SHSS	8 side blade Ø 120 mm, in H.S.S. steel
12DHSS	12 side blade Ø 120 mm, in H.S.S. steel
12CSW	Circular blade Ø 120 mm, in Extra steel
12SHSSTN	8 side blade Ø 120 mm, in H.S.S. steel covered with TIN
12DHSSTN	12 side blade Ø 120 mm, in H.S.S. steel covered with TIN
12SMD	8 side blade Ø 120 mm, in hard integral metal

The technical data are only indicative and they can be changed without notice.

6. RUMOR LEVEL

The maximum acoustic pressure level emitted by bench cutter SW12 is about 60 dB (A). Noise tests have been carried out in compliance with Standard ISO 11202 (1995). The device noise levels, measured at different distances (without any sound wave filtering system), vary in the extent of few db (A).

NOTE

It is advisable for bench cutter SW12's owners to verify the compliance with the standard concerning safety of workers: Italian legislative decree N.277 ITEM IV (DATED 15-08-91). The use of ear protecting devices is compulsory.

7. FIELD OF APPLICATION

Bench cutter SW12 has been designed, manufactured and assembled to cut every kind of fabrics or materials, with the exception of metal, plastic or wood, by means of rotary polygonal blades.

This equipment must not work:

- in areas prone to explosions;
- in presence of fine dust or corrosive gases;
- on wet or damp materials;
- to cut plastic, metal and wooden materials.

It is forbidden to use bench cutter SW12 for purposes different from the above-mentioned ones.

8. USE WARNINGS

We recommend following the indications below in order to always work in safety conditions.

- All the operations must be carried out complying strictly with the safety rules of the country where the device is to be installed.
- It is **STRICTLY FORBIDDEN** to smoke during the installation or adjustment operations of the bench cutter.
- The Customer undertakes to comply with and make his staff observe **all** the rules and regulations in force concerning safety, prevention of accidents and health in the work place. Therefore, the Customer assumes the responsibility to strictly follow **all** the rules and regulations in force, as well as the special provisions in force in sport and public installations the Customer declares to know after receiving **all** the relative necessary information.
- The bench cutter works also without their safety protective device. This protective device must **NEVER** be removed.
- Always check the resistance of the material to be cut and the kind of blade which is being used.
- The Customer shall equip his own personnel with **all** the individual safety protections for the execution of the works, as well as with the ones which might be prescribed by the Manufacturer due to specific danger conditions of the plant or of the area where the personnel must work.
- Only one operator must use the bench cutter always standing behind the guide handle. Do not make any adjustment while the blade is working or while the electric plug is connected.
- Always pay attention to the electric cable position to prevent it from being cut or damaged by the blade.
- It is allowed to assemble bench cutter SW12 on machines O.E.M. on condition that their original structure is not modified. Otherwise, the intervention must be certified by Rasor®.

9. ELECTRIC CONNECTION

Firstly make sure that the lines are able to feed the cutter correctly, in compliance with the safety rules (for the feature required see par. 5).

WARNING



We suggest installing a magnetothermic safety device before the cutter and check that the ground circuit is effective. Before working on the feeding cable pull the plug out. Check that electric connections and protections correspond to the driving force and the plate data values (voltage and current), required by the different electric circuits. Possible faulty ground connections make the working conditions unsafe. Possible damages are not charged to Rasor®. By referring to the EC 11-27/1 standard all the works carried out by means of electric current must be performed by a staff, who has been provided with all the devices required by the above-mentioned standard. For the works carried out under voltage, it is necessary that the employer certifies the suitability, against formative processes. As the cutter SW12 is supplied without plug, the user must use a plug homologated in the country in which the cutter is used. In the European Countries a Shuko plug is required (see picture 3). The electric cable is equipped with yellow and green grounding. Never change the length of the cable supplied.

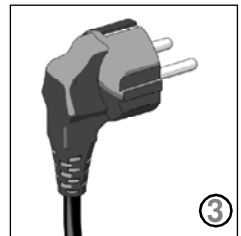

10. RESIDUAL RISKS

Even though the bench cutter is safe, operators must pay attention to preserve their and other people's safety.

- ⊗ At the end of the working operations, the motor could be very hot.
- ⊗ The cutting blade can work even when the protective device is disassembled.

11. USE

To use the bench cutter manually, proceed as follows:

- 1) Lay the material to be cut on a table;
- 2) Connect the cutter to the electric feeding (see picture 4);
- 3) Put the material on the cutting foot;
- 4) Adjust the front mobile protection according to the thickness of the material to be cut;
- 5) Enable the switch; once it has been enabled, it lights with a green light (see picture 5);
- 6) Press the starting lever after having moved the safety catch (see picture 6);
- 7) Push the bench cutter to the desired direction, by trying to put the material in front of itself as stretched as possible, preventing it from curling in the front part of the cutter. To work, the cutter must be placed on a surface and must slide by means of the rolls placed under the sliding platform.

NOTE:

The thrust on the bench cutter must be as uniform as possible. To carry out linear cuts with precision (and to follow predetermined paths), we also recommend using the arrow point (see point "A" in picture 7).

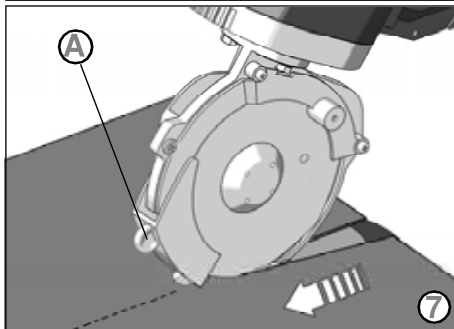
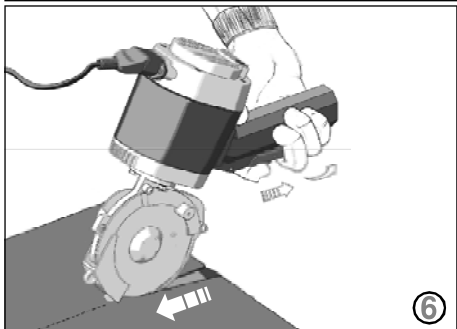
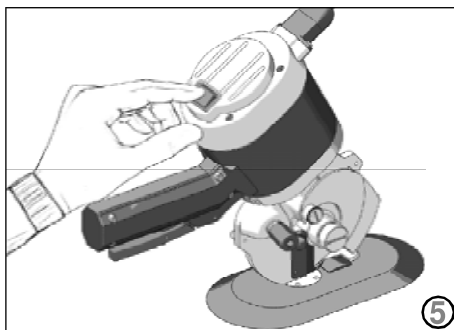
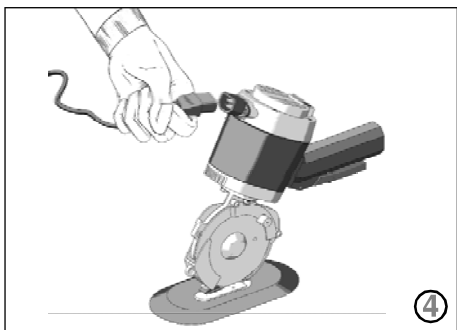

12. BLADE SHARPENING

After many hours of a continuative use of the bench cutter, or if it would not be able to cut anymore, it is necessary to sharp the blade.

To carry out this operation, start the blade and press sharpener "2" located on it 3-4 seconds (by pressing push button "1", as shown in picture 8).

Repeat the operation 2-3 times.

If the sharpening operation is not effective, check the wear of emery grinding wheel "3" (see picture 9).

If grinding wheel "3" is too worn or dirty, replace it.

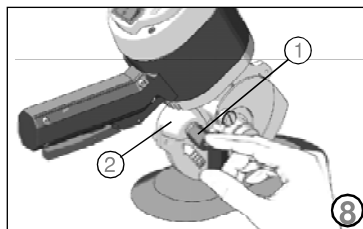

13. LUBRICATION

Every 3-4 working hours, it is necessary to lubricate the pair of gears. To carry out this operation, remove protective plug "A" located on the motor support of the bench cutter and fill it with lubricating grease Rasor. Screw plug "A" again few turns. Screw plug "A" some turns every 2-3 working hours (see picture 10).

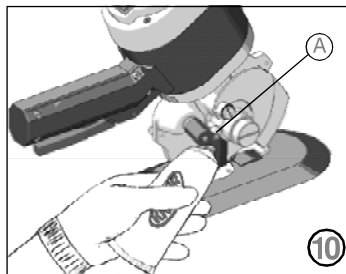

WARNING



The blade must never be dirty with grease or oil.

14. MOTOR BRUSH REPLACEMENT

Worn motor brushes could create a cutter malfunction (no starting, intermittent start, etc.), therefore it should be better to verify their wear periodically.

Open the motor cover by unscrewing 4 screws "4" on the cutter head (see picture 11).

Remove the metal contacts that close the brushes with a slotted screwdriver (see picture 12).

Remove the brushes and check their wear: if the graphite has a lenght lower than 15 mm or it is uneven, replace it (see picture 13).

Close the metal contacts again by making sure that they adhere well to the metal part of the brush. Finally close the motor cover again.

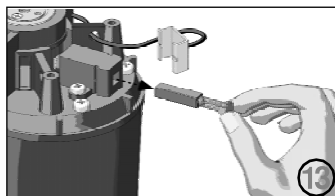
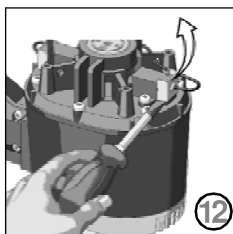
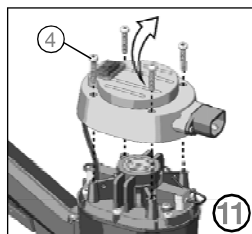

15. BLADE REPLACEMENT

If the blade is no more able to cut (even after repeating the sharpening operation several times) it is necessary to replace it. To carry out this operation, use butterfly wrench "1" and drift "3" locking the blade (shown in picture 14).

To replace the blade, proceed as follows:

- 1) Use some protective gloves in compliance with Legislative Decree 242 dated 19 March 1996 (use of personal protection devices);
- 2) Remove the fixed rear safety protection "A" (see picture 15) by unscrewing the three cross screws "C", "D" and "E" by means of a screwdriver (not supplied by the manufacturer) as shown in picture 16. Remove the mobile front safety protection "B" (see picture 15) by unscrewing pin "F" and removing the two washers "G" as shown in picture 16.
- 3) Insert drift "3" (see picture 14) into hole "H", so as to lock the blade (the hole on the blade must correspond to the one on the structure).
- 4) Use butterfly wrench "1" to unscrew nut "L" and remove blade "M" (see picture 17).
- 5) Replace the worn blade with the new one "2", being careful to center the blade on the shaft, in the correct position, and remember to assemble it with the side with the writing Rasor positioned towards the external side of the bench cutter.
- 6) Assemble all the components again and carry out the sharpening.

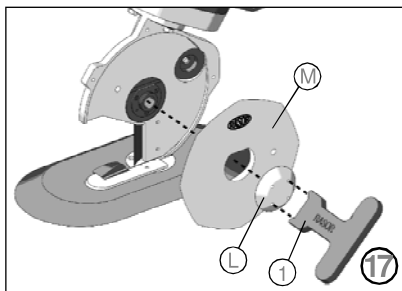
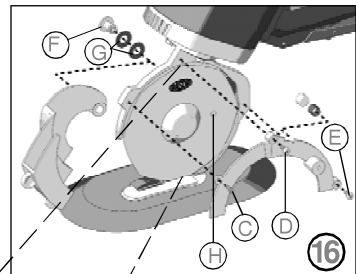
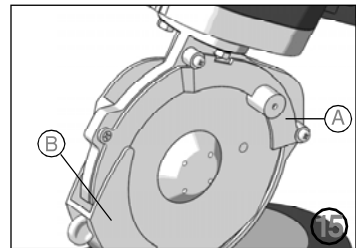
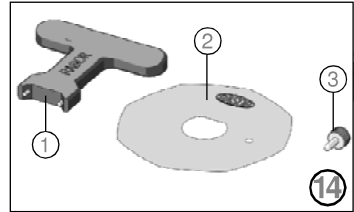

16. TROUBLESHOOTING

✘ PROBLEM

⇒ SOLUTION

The fabric is not cut or it gets stuck between the blade and the counterblade

Check that the blade and the counterblade contact with each other

Check the kind of fabric

Sharpen the blade

Check the fabric thickness

Check the compatibility between blade and fabric

Make sure that the motor turns correctly

Reduce the feeding speed

Check the counterblade integrity

Carry out the lubrication

Disassemble the blade and remove the material residues

Check the wear of the pair of gears

Check the protection fuse

Check the electric connections

Check the motor brushes

Check the feeding cable

The cutter is noisy

The cutter starts slowly, workd intermittently or it does not start

17. SPARE PARTS / EXPLODED VIEW

CODE	DESCRIPTION	CODE	DESCRIPTION	CODE	DESCRIPTION	CODE	DESCRIPTION
12SH55	8-SIDE BLADE Ø 120 mm, H.S.S. STEEL	SW121800	WORM SCREW	SW1274CPL	COMPLETE PLATFORM	T 102900	HANDLE SWITCH WITH LIGHT, OLD TYPE
SW104102	OILER RING	SW121801CPL	COMPLETE PAIR OF GEAR	SW127500	BEARING ADJUSTMENT	T 102902	HANDLE PUSH BUTTON, OLD TYPE
SW104103	OILER RING SPRING	SW121900	LOWER MOTOR CAP	SW127501	BEARING ADJUSTMENT FIXING GRAIN	T 102903	LEVER PUSH BUTTON
SW107101	COMPLEMENT FOOT	SW122000	UPPER MOTOR CAP	SW127600	CLOSE CAP	T 102904	CAP SWITCH WITHOUT LIGHT
SW107701	COUNTERBLADE SPRING FIXING SCREW	SW122901F	FEEDING ELECTRONIC CIRCUIT (WITH FUSE)	SW127700	COUNTERBLADE SPRING	T 102904L	CAP SWITCH WITH LIGHT, SERIES 2008
SW107900	COUNTERBLADE HOLDER FIXING SCREW	SW1229F10	2,5 AFUSE FOR FEEDING CIRCUIT	SW127800	PLATFORM SECTOR	T 102906	RATCHET AND LEVER FIXING PIN
SW108000	COUNTERBLADE HOLDER	SW124100	FIX REAR PROTECTION	SW128600	Ø 30x10x6 EMERY, MEDIUM -GRAINED	T 102908	SWITCH LEVER
SW108100	WIDIA COUNTERBLADE	SW124101	3x10 MA SCREW REAR GUARD FIXING	SW1286CPL	COMPLETE EMERY UNIR, MEDIUM-GRAINED	T 102908CPL	COMPLETE LEVER
SW108200	COUNTERBLADE FIXING SCREW	SW124102	3x5 MA SCREW REAR GUARD FIXING	T 100102	MOTOR CAP WITH SLOT	T 102909	LEVER RATCHET
SW106700	EMERY PIN	SW1241CPL	REAR PROTECTION SET	T 100200	MOTOR CAP FIXING SCREW	T 102910	RATCHET SPRING
SW108800	EMERY SPRING Ø 11 mm	SW124400	FRONT PROTECTION GUARD	T 100201	SOCKET SCREW	T 103000	HANDLE SWITCH/PUSH BUTTON FIXING SCREW
SW108900	SHARPENER BUSH	SW124402	FRONT PROTECTION FIXING SCREW	T 100300	ADJUSTMENT LOCKING SCREW	T 104501	PAIR OF CONVEXED WASHERS
SW109000	EMERY SPRING Ø 6 mm	SW1244CPL	FRONT PROTECTION SET	T 100600	MOTOR BRUSHES	T 104700	GREASER CAP
SW109100	EMERY CAP	SW124900	PLATE BLOCKING THE THREAD	T 100700	BRUSH HOLDER	T 104800	GREASER
SW109200	EMERY CAP FIXING SCREW	SW125501	COMPLETE MOTOR SUPPORT	T 100800	BRUSH HOLDER CLIP	T 105000	SPRING BLOCKING THE THREAD FIXING SCREW
SW109300	WASHER	SW125600	SUB-BLADE RING	T 100900	BRUSH HOLDER FIXING SCREW	T 105200	MOTOR SUPPORT FIXING BOLT
SW120400	MOTOR BEARING ADJUSTMENT	SW126101	BLADEGUIDE SERIES >2001	T 101801	ELASTIC PIN	T 105300	WASHER
SW120500	CORRUGATED THRUST BEARING PAIR	SW126102	REFERENCE PIN	T 102001	UPPER CAP FIXING SCREW	T 105400	ANTI-FRICTION BUSH
SW121000	MOTOR BEARING L9	SW126103	GEAR RING FIXING SCREW	T 102100	LOWER CAP FIXING SCREW	T 106400	BEARING PIN
SW121200	ANTI-GREASE WASHER	SW126201	GEAR RING	T 102200L	MOTOR FRAME WITH MAGNETS	T 106800	ROLLER FIXING SCREW
SW121300	COMPLETE ROTOR 220 V	SW126300	RING NUT FIXING THE BLADE	T 102201	PAIR OF PERMANENT MAGNETS	T 107000	PLATFORM AND SECTOR FIXING SCREW
SW121301	COMPLETE ROTOR 110 V	SW126500	PLATFORM ROLLER BEARING	T 102300L	HANDLE SECTOR	T 107500	BLADE ASSEMBLING/DISASSEMBLING KEY
SW121302	COMPLETE ROTOR 48 V	SW126501	BEARING WASHER	T 102400	HANDLE SECTOR FIXING SCREW	T 107600	DRIFT LOCKING THE BLADE
SW121500	FAN	SW1265CPL	SLIDING ROLLER SET	T 102701	L PLUG WITH FROMMET	T 107900	LUBRICATING GREASE
SW121600	MOTOR BEARING L12	SW127201	GEAR BEARING R6	T 102702	SOCKET		
SW121700	ELASTIC RING	SW127400	SIMPLE PLATFORM	T 1027CPL	FEEDING CABLE WITHOUT PIN		

WARRANTY

Razor® Elettromeccanica S.r.l. bench cutter has a 12 month warranty from the date indicated on the last page of this manual, except in case of different written agreements.

The warranty covers all manufacturing and material defects. Replacement and repair operations are covered only if carried out by our company and at our workshop.

The material to be repaired must be sent CARRIAGE FREE.

Once the machine has been repaired, it will be sent CARRIAGE FORWARD to the customer.

The warranty covers neither technicians' intervention on site nor the machine disassembly from the installation place.

If for practical reasons, one of our technicians is sent to the premises, the customer will be charged the costs plus the travelling expenses.

The warranty does not include:

- ☞ failure caused by wrong use or assembly,
- ☞ failure caused by external agents,
- ☞ failure caused by lack of maintenance or negligence;
- ☞ blades and parts subject to wear.

WARRANTY FORFEITURE:

- ☞ In case of arrearage or other breaches of contract,
- ☞ Whenever changes or repairs are carried out on our cutters without our prior authorization,
- ☞ Whenever the serial number is tampered with or cancelled,
- ☞ Whenever the damage is caused by improper use, bad treatment, bumps, falls and other causes not due to normal working conditions,
- ☞ Whenever the unit seems tampered with, dismantled or previously repaired by unauthorized staff,
- ☞ In case the bench cutters are used for purposes that are different from the ones described in this manual.

All repair operations carried out under warranty do not interrupt its duration.

All disputes will be settled in the court of justice of Milan (Italy).

We thank you in advance for the attention you will pay to this manual and we invite you to inform us of any change you deem necessary to improve it and make it more complete.

RASOR ELETTROMECCANICA SRL

Via Vincenzo Caldesi 6

20161 Milan · Italy

ph. +39 02 66 22 12 31

fax +39 02 66 22 12 93

info@rasor-cutters.com

www.rasor-cutters.com

FOLLOW US:

